

A modern interior scene featuring a blue table, a potted plant, and framed art. The background is a dark blue wall with two framed abstract artworks. A large green plant is positioned to the right. The foreground shows a white table with a blue top and a wooden slatted base.

# treesse

DESIGN  
FOR  
LIFESTYLE

*MADE IN ITALY*

LYON 2024

# treesse

DESIGN BY

SADLER

ICE	4
ROCK	8
STEP-BOX	12
ARTICA	14
SOUL SPA	18
PHANTOM	24
ZEN ACTIVE	26
HEAVEN	28
SHADOW	30
BREEZE	32
SUPERQUARZ	36
QUARZ LIGHT	38
AQUARUN	40
ACCESSORIES	46
MIRAGE	48
AURA	52
PRODUCT OVERVIEW	56

# DESIGN FOR LIFESTYLE



# ICE

L. 225 X P. 225 X H. 95 cm

L'ELEGANZA DEL VETRO ENFATIZZA L'EFFETTO SUGGESTIVO DEL BORDO A SFIORO. UN TOCCO DI LEGGEREZZA, CHE AUMENTA IL SENSO DI CONTINUITÀ VISIVA TRA LO SPAZIO INTERNO E QUELLO ESTERNO GRAZIE AL GIOCO DEI RIFLESSI SULLA SUPERFICIE TRASPARENTE. L'ESPERIENZA DI RELAX DIVENTA COSÌ ANCORA PIÙ IMMERSIVA. ICE PUÒ ACCOGLIERE FINO A 5/6 PERSONE; I DUE CUSCINI PIÙ AMPI NASCONDONO I COMANDI E SI TRASFORMANO IN COMODE SEDUTE.

The elegance of the glass highlights the beautiful effect of the infinity edge. A touch of lightness that increases the sense of visual continuity between interior and exterior thanks to the reflections playing on the transparent surface. The relaxing experience becomes even more immersive. ICE can accommodate up to 5/6 people; the two wider cushions hide the controls and turn into comfortable seats.

L'élégance du verre souligne l'effet saisissant du spa à débordement. Une touche de légèreté qui renforce le sentiment de continuité visuelle entre l'espace intérieur et extérieur grâce au jeu des reflets sur la surface transparente. L'expérience de détente devient ainsi encore plus immersive. Ice peut accueillir jusqu'à 5/6 personnes. Les grands coussins dissimulent les commandes et se transforment en sièges confortables.



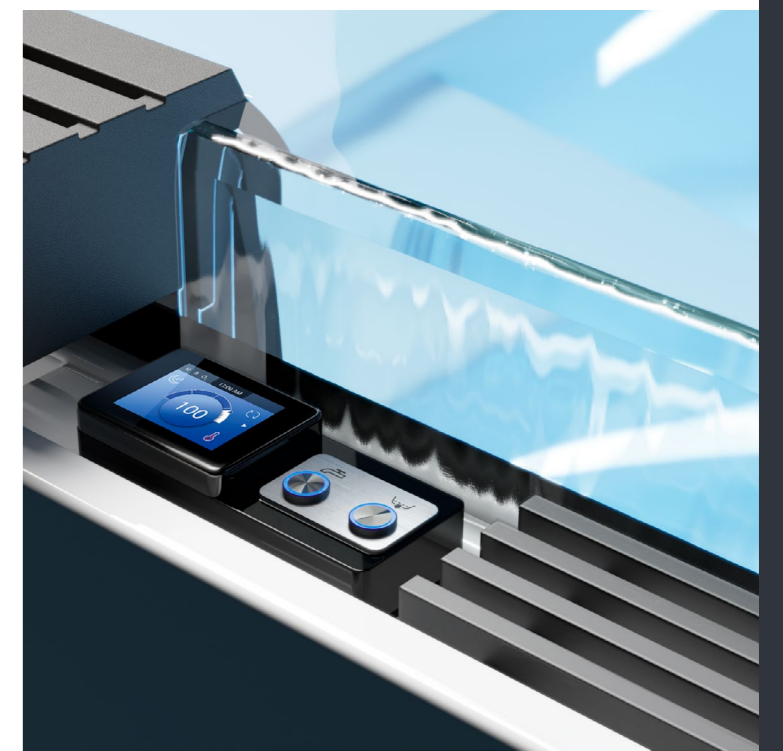
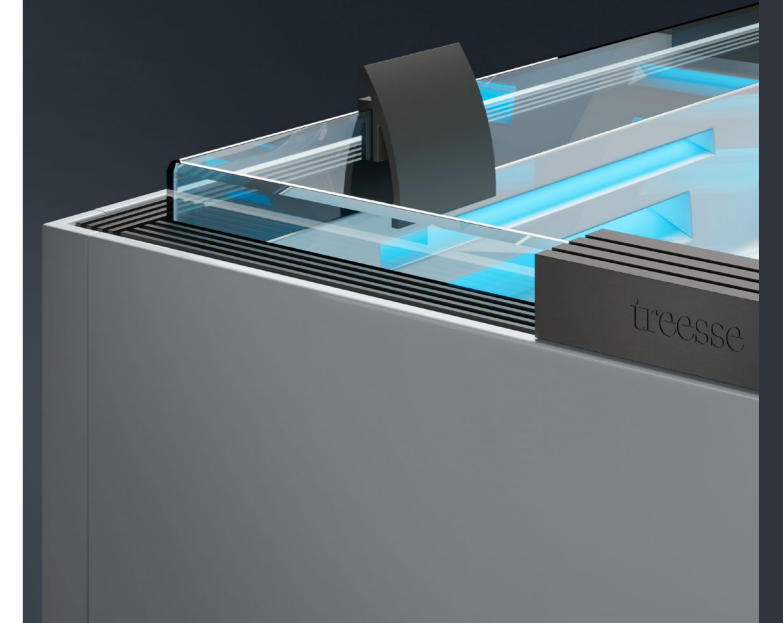
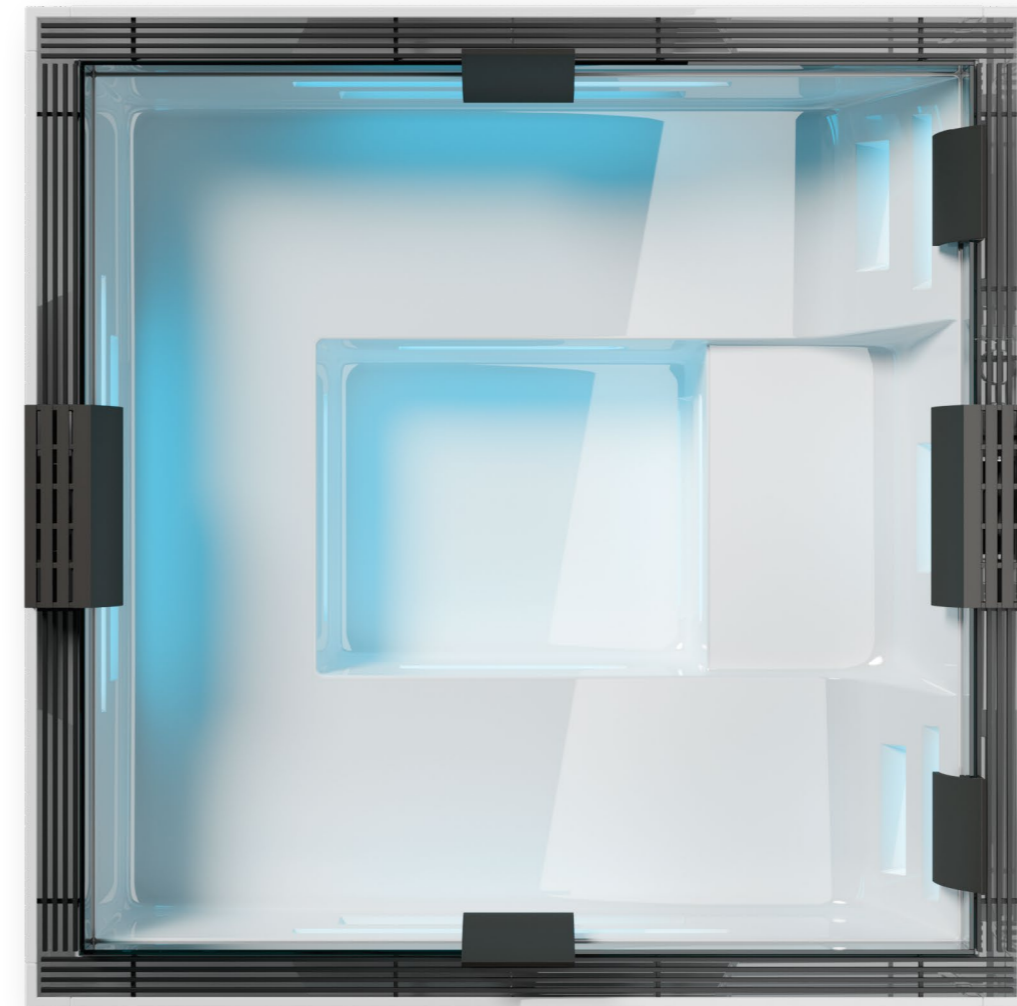
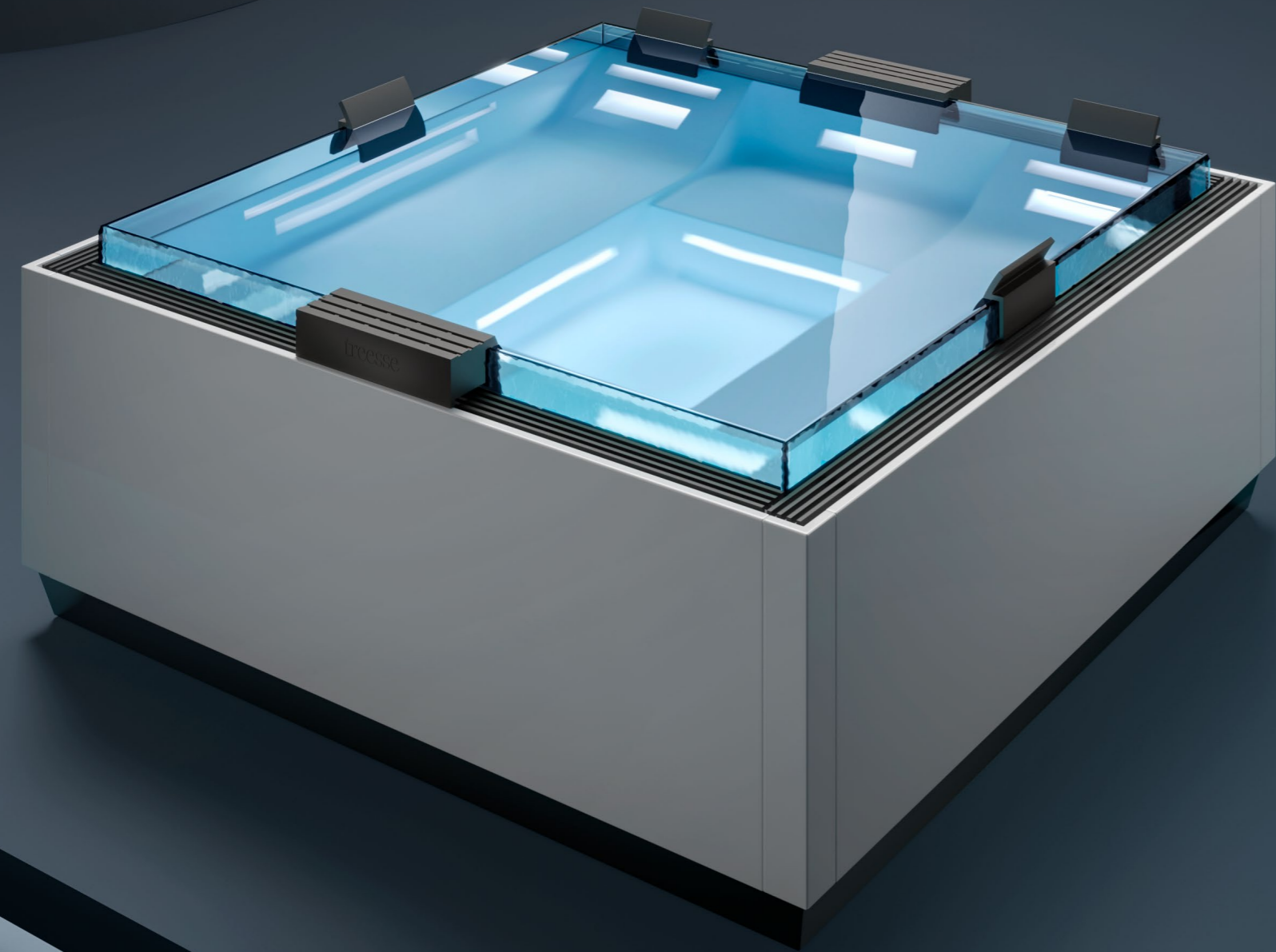

ICE  
L. 225 X P. 225 X H. 95 cm

Colore pannello  
Panel colour  
Couleur du panneau



Bianco  
White  
Blanc

# ROCK

L. 210 X P. 225 X H. 95 cm

LA MINIPISCINA IDROMASSAGGIO ROCK SI RIVOLGE A COLORO CHE RICERCANO UN'ESTETICA ISPIRATA AGLI AMBIENTI NATURALI. IL SUO RIVESTIMENTO SPECIALE IN GRES PORCELLANATO, CON EFFETTO PIETRA NATURALE, OFFRE UNA SENSAZIONE MATERICA E RAFFINATA SIA ALLA VISTA CHE AL TATTO, INVITANDO AL RELAX. AL TEMPO STESSO RISPETTA GLI ALTISSIMI STANDARD DI RESISTENZA E SICUREZZA DELLE NOSTRE MINIPISCINE. È ABBINABILE AL SISTEMA DI ACCESSO STEP-BOX IN UNA DELLE NUOVE FINITURE IN GRES.

The hydromassage spa Rock is ideal for those seeking an aesthetic inspired by natural environments. Its special porcelain stoneware covering with a natural stone effect offers a refined, textured sensation through both sight and touch, inviting relaxation. All while simultaneously respecting the utmost strength and safety standards of our spas. Rock can be combined with our Step-Box entry system in one of the new stoneware finishes.

La mini-piscine hydromassage Rock s'adresse à ceux qui recherchent une esthétique inspirée des milieux naturels. Son revêtement spécial en grès cérame avec effet pierre naturelle, offre une sensation matiériste et raffinée à la fois à la vue et au toucher, invitant à la détente. De plus, il respecte les normes les plus élevées de résistance et de sécurité de nos mini-piscines. Il peut être combiné avec le système d'accès Step-Box dans l'une des nouvelles finitions en grès cérame.





ROCK  
L. 210 X P. 225 X H. 95 cm

Finitura  
Finish  
Finition

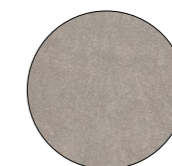

Piasentina Flamed

# STEP-BOX

STEP-BOX È UN SISTEMA DI ACCESSO ALLE MINIPISCINE TREESSE STABILE, SICURO, COMPLETAMENTE MODULARE. I DIVERSI GRADINI CHE COMPONGONO LA COLLEZIONE SI POSSONO COMBINARE PER RISPONDERE CON ELEGANZA A OGNI ESIGENZA DI SPAZIO. I GRADINI DI STEP-BOX SONO RIVESTITI DA LASTRE IN GRES A EFFETTO PIETRA NATURALE, ANTISCIVOLO, DI 20 MM DI SPESSORE. RIVESTIMENTO DISPONIBILE IN 3 COLORI: NUIT, CEMENTO, GESSO

Step-box is a stable, safe and completely modular access system for entering Treesse spas. The various materials in the collection can be combined to elegantly suit any needs in terms of space. The step-box steps are covered with non-slip, natural stone-effect stoneware slabs 20 mm thick. The covering is available in 3 colour finishes: Nuit, Cemento, Gesso.

Step-box est un système d'accès stable, sûr et entièrement modulable pour les mini-piscines Treesse. Les différentes marches qui composent la collection peuvent être combinées pour répondre élégamment à toutes les exigences d'espace. Les marches du Step-box sont recouvertes de dalles antidérapantes en grès avec effet pierre naturelle de 20 mm d'épaisseur. Le revêtement est disponible en 3 couleurs : Nuit, Cemento, Gesso.

Disponibile in abbinamento con minipiscine Ghost e Ghost Plus.  
Available to match the Ghost and Ghost Plus spas.  
Disponibile en combinaison avec les mini-piscines Ghost et Ghost Plus

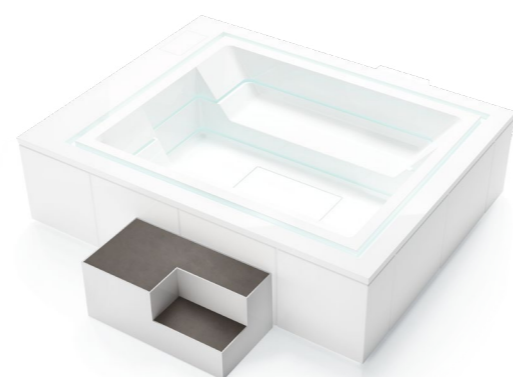

**STEP-BOX 115**

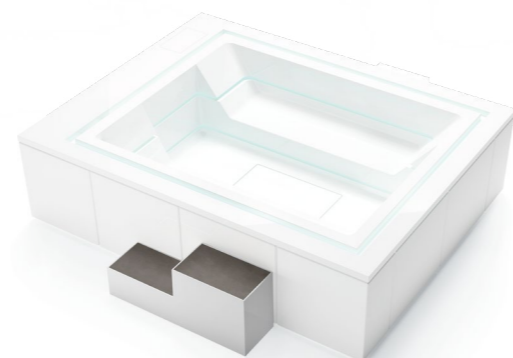

**STEP-BOX 120**

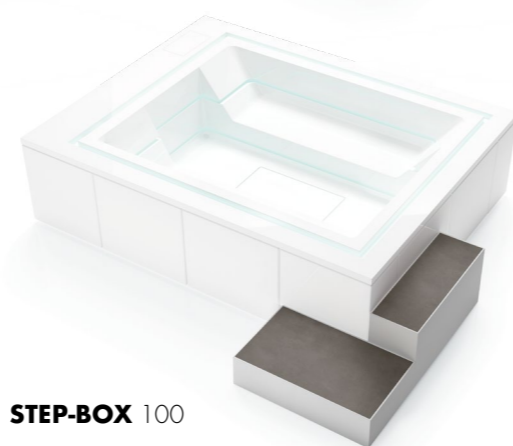

**STEP-BOX 100**

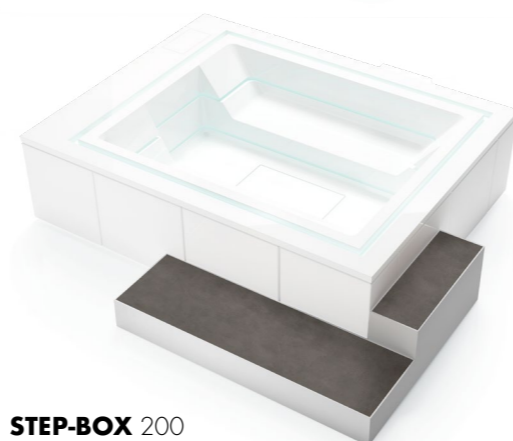

**STEP-BOX 200**

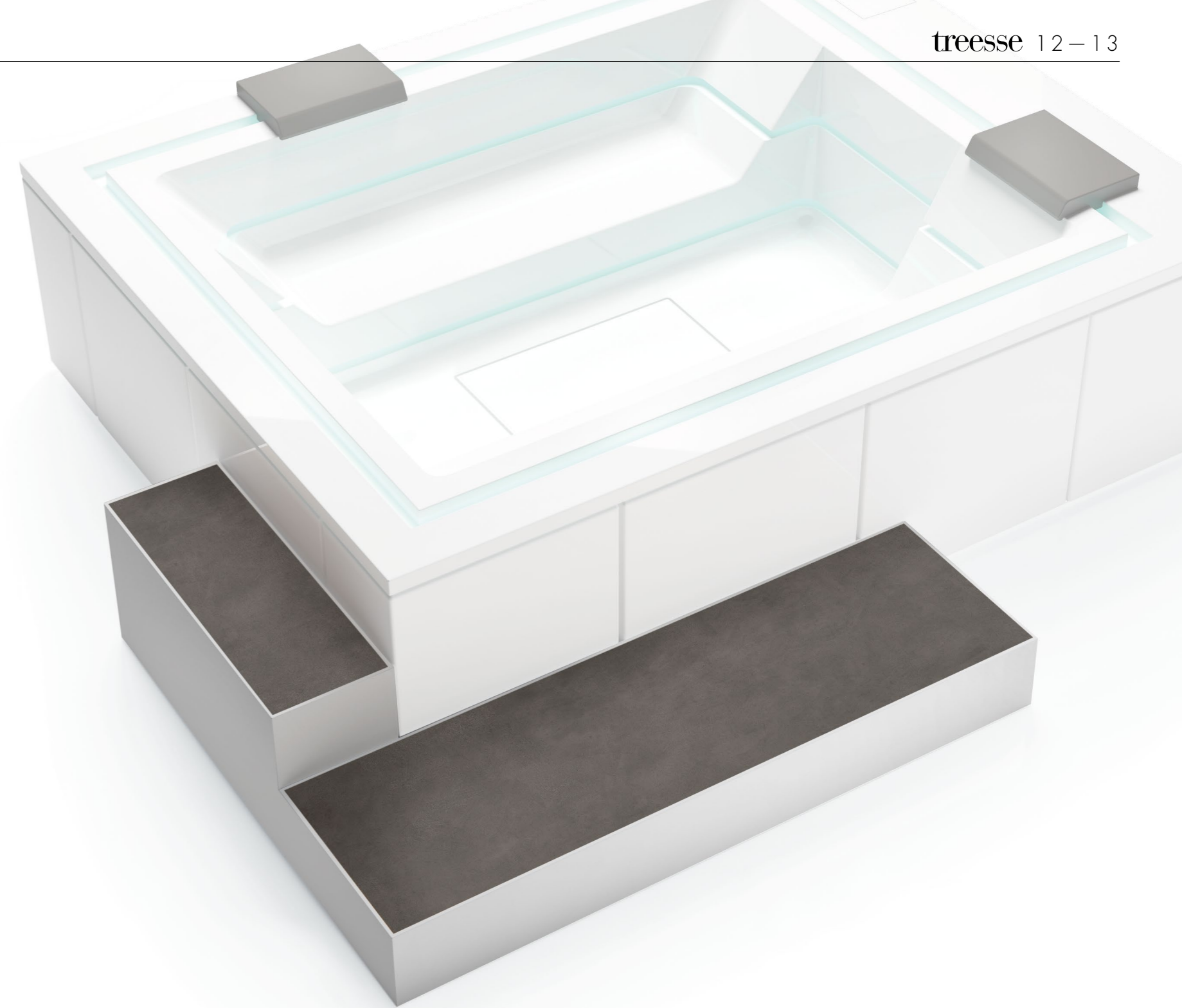

Finitura gres  
Stoneware finish  
Grès finition

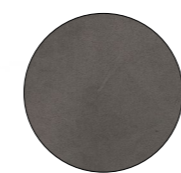

Nuit

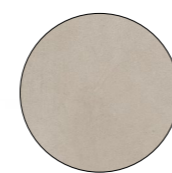

Cemento

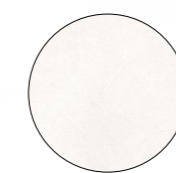

Gesso



# ARTICA

L. 195 X P. 90 X H. 80 cm

ARTICA È UNA NUOVA VASCA PER CRIOTERAPIA STUDIATA PER UNIRE LA MASSIMA FUNZIONALITÀ TECNICA A UN'ESTETICA ELEGANTE E MINIMALISTA. I BENEFICI DEI "BAGNI DI GHIACCIO" SONO ORMAI NOTI: ACCELERANO I TEMPI DI RECUPERO DOPO L'ATTIVITÀ FISICA INTENSA, PREVENGONO L'INSORGENZA DI INFIAMMAZIONI E MIGLIORANO LE PRESTAZIONI. ARTICA È PENSATA PER ABITAZIONI PRIVATE, PALESTRE, CENTRI SPORTIVI... OVUNQUE VI SIANO AMANTI DELLO SPORT.

Artica is a new Cryotherapy tub designed to combine maximum technical functionality with an elegant, minimalist aesthetic. The benefits of "ice baths" are well known: they accelerate recovery time after intense physical activity, prevent inflammation and improve performance. Artica is designed for private homes, gyms, sports centres... anywhere sports are enjoyed.

Artica est une nouvelle baignoire pour la cryothérapie conçue pour allier la meilleure fonctionnalité technique à une esthétique élégante et minimaliste. Les bienfaits des « bains de glace » sont désormais connus : ils accélèrent les temps de récupération après une activité physique intense, préviennent l'apparition d'inflammations et améliorent les performances. Artica est conçue pour les maisons privées, les gymnases, les centres sportifs... partout où il y a des amateurs de sport.





ARTICA  
L. 195 X P. 90 X H. 80 cm



ARTICA con contenitore / with storage compartment / avec rangement  
L. 195 X P. 135 X H. 80 cm



ARTICA È DISPONIBILE ANCHE NELLA VERSIONE CON VANO CONTENITORE LATERALE, PER RIPORRE LA COPERTURA DELLA VASCA.

Artica is also available in a version with a lateral storage compartment for storing the tub cover.

Artica est également disponible dans la version avec compartiment latéral pour le rangement de la couverture de la baignoire.



Colore pannello  
Panel colour  
Couleur du panneau

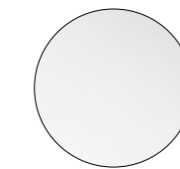

Bianco satinato  
Satin white  
Blanc satiné



Nero satinato  
Satin black  
Noir satiné

ARTICA con contenitore / with storage compartment / avec rangement

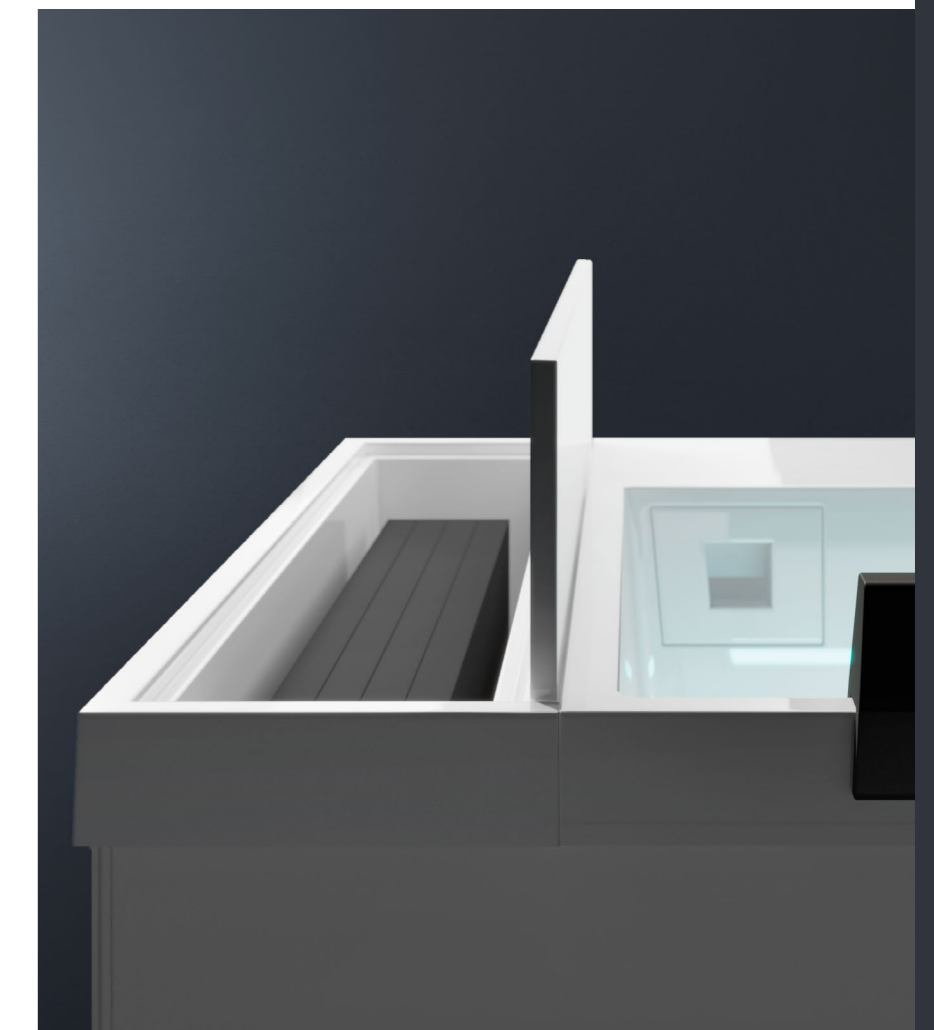

# SOUL SPA

L. 195 X P. 150 X H. 70 cm

L. 195 X P. 120 X H. 70 cm

ESTREMA PULIZIA VISIVA E COMFORT ASSOLUTO:  
LA NUOVA SOUL SPA È UNA MINIPISCINA IDROMASSAGGIO  
CAPACE DI INTEGRARSI AL MEGLIO IN OGNI AMBIENTE.  
LA POTENZA DEL SISTEMA IDROMASSAGGIO GHOST TROVA SPAZIO,  
COSÌ, ANCHE IN UNA CAMERA DI UN ALBERGO  
O IN UN ALTRO AMBIENTE DALLE DIMENSIONI RIDOTTE.  
È DISPONIBILE IN DUE DIVERSE DIMENSIONI, PER ACCOGLIERE  
AGEVOLMENTE UNA OPPURE DUE PERSONE.

Extreme clean visuals and absolute comfort:  
the new Soul Spa is a hydromassage spa that can be integrated into any environment.  
Thus, the power of the Ghost whirlpool system also finds space in a hotel room or other small environment.  
It is available in two different sizes, to easily accommodate one or two people.

Clarté visuelle extrême et confort absolu : le nouveau Soul Spa est une mini-piscine  
d'hydromassage qui s'intègre parfaitement dans tout environnement.  
La puissance du système d'hydromassage Ghost peut ainsi s'adapter à une chambre  
d'hôtel ou à tout autre espace restreint. Il est disponible en deux tailles différentes pour  
accueillir confortablement une ou deux personnes.



SOUL SPA 150  
L. 195 X P. 150 X H. 70 cm

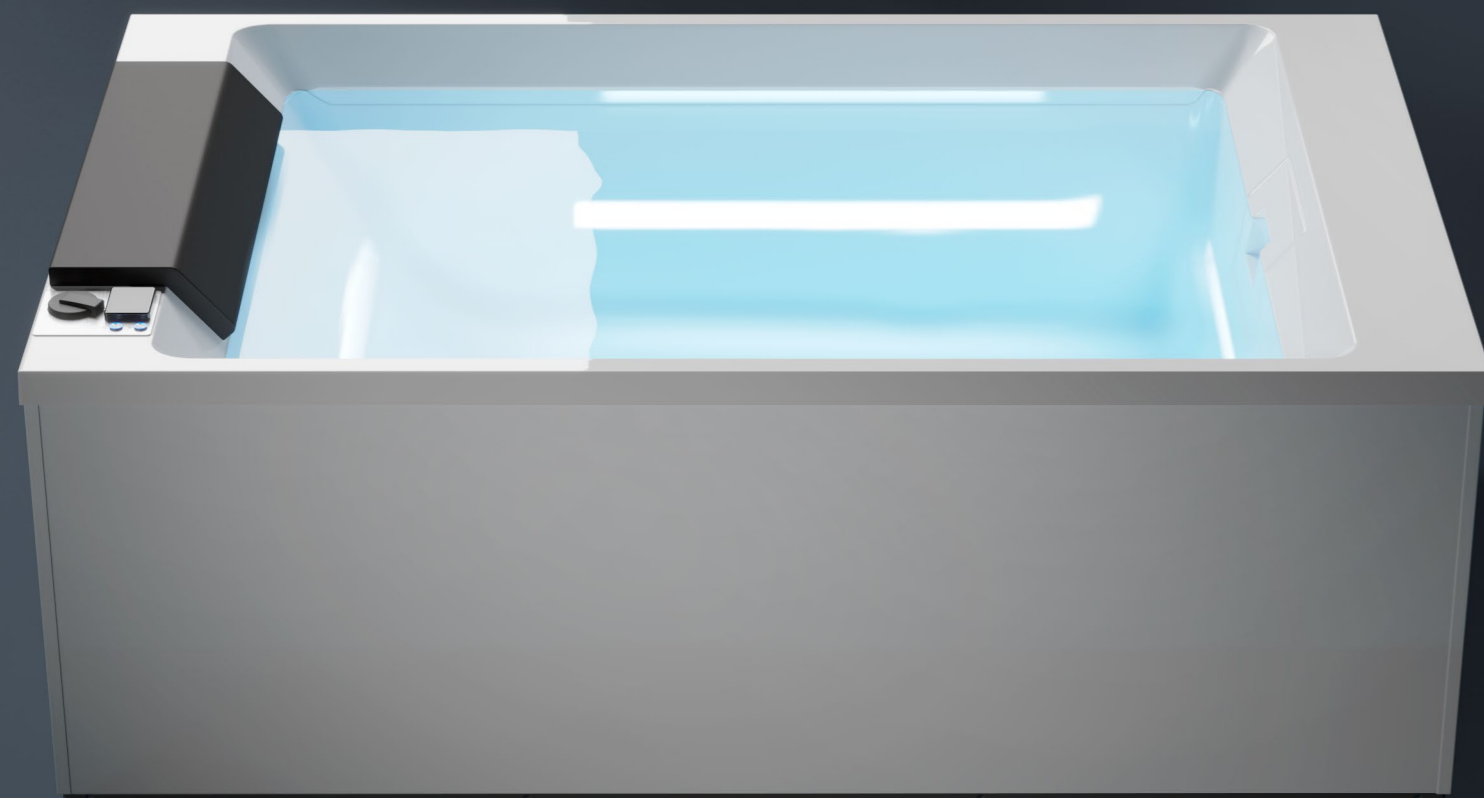

I DETTAGLI FUNZIONALI, INCLUSO LO SCARICO, SONO NASCOSTI ALLA VISTA. ELEGANZA ED ERGONOMIA AUMENTATA SONO IL RISULTATO DI UN ATTENTO LAVORO DI PROGETTAZIONE.

Its functional details, including the drain, are hidden from view. Elegance and increased ergonomics are the result of careful design work.

Les détails fonctionnels, y compris l'évacuation, sont dissimulés. L'élégance et l'ergonomie accrue sont le résultat d'un travail de conception minutieux.

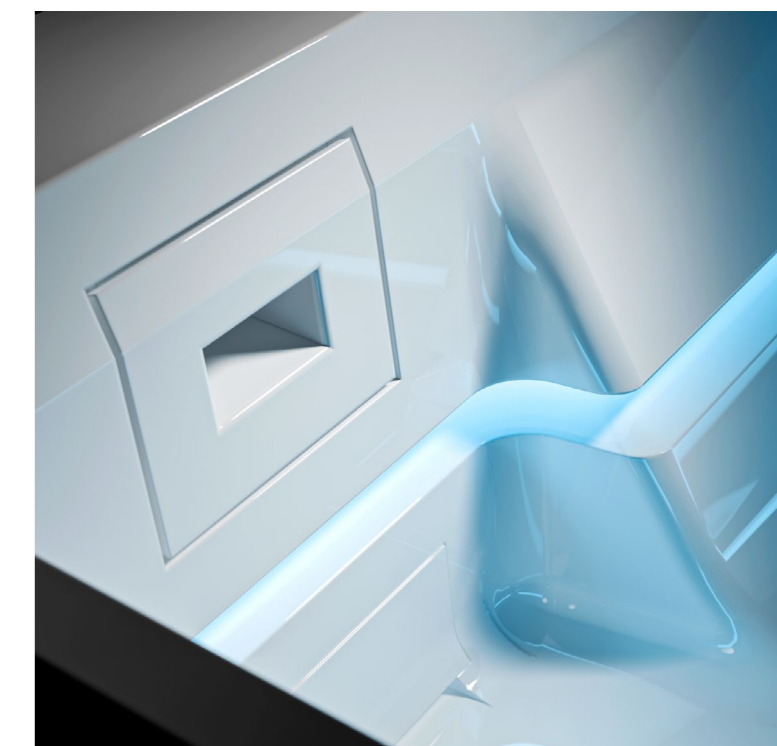
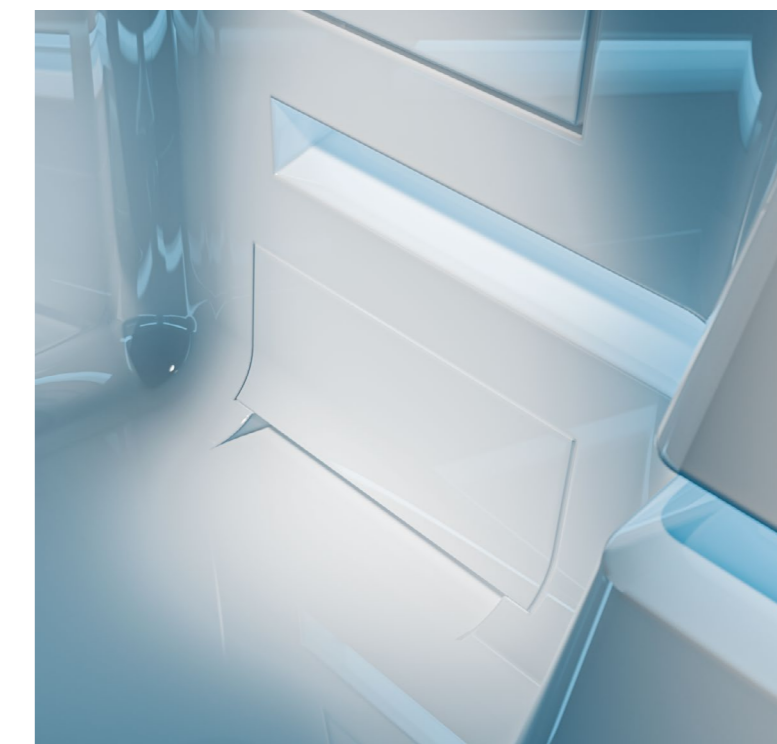



SOUL SPA 150  
L. 195 X P. 150 X H. 70 cm



SOUL SPA 150 con contenitore / with storage compartment / avec rangement  
L. 195 X P. 193 X H. 70 cm



SOUL SPA 120  
L. 195 X P. 120 X H. 70 cm



SOUL SPA 120 con contenitore / with storage compartment / avec rangement  
L. 195 X P. 163 X H. 70 cm

TRA GLI OPTIONAL È DISPONIBILE UN PRATICO ED ELEGANTE VANO CONTENITORE, INTEGRATO NEL DESIGN DELLA VASCA E STUDIATO PER RIPORRE COMODAMENTE LA COPERTURA DELLA MINIPISCINA.

The optional include a practical and elegant storage compartment integrated into the tub's design, conceived to comfortably store the spa's cover.

Un compartiment de rangement pratique et élégant, intégré au design du spa et conçu pour ranger la couverture de la mini-piscine, est disponible en option.

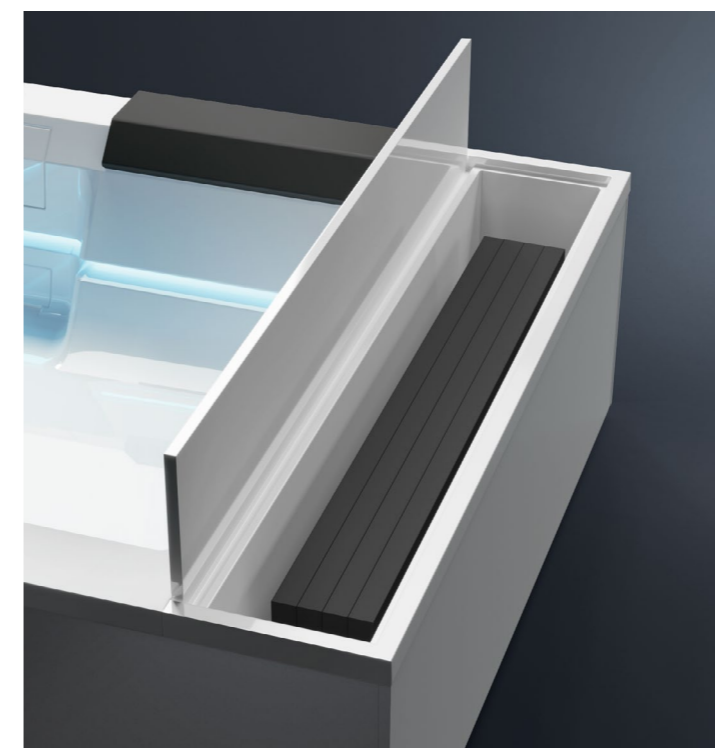

Colore pannello  
Panel colour  
Couleur du panneau



Bianco satinato  
Satinwhite  
Blanc satiné



Nero satinato  
Satin black  
Noir satiné

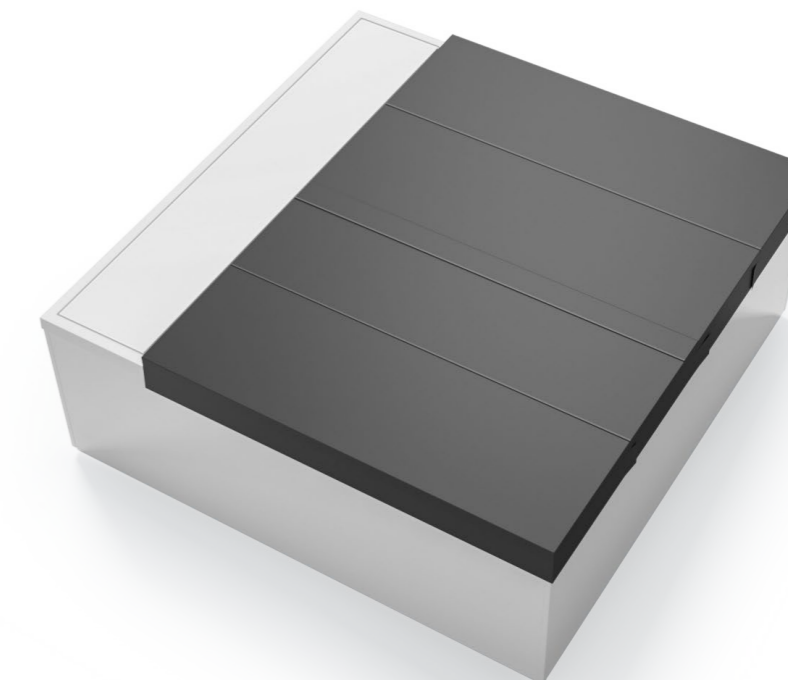

SOUL SPA 150 con contenitore / with storage compartment / avec rangement

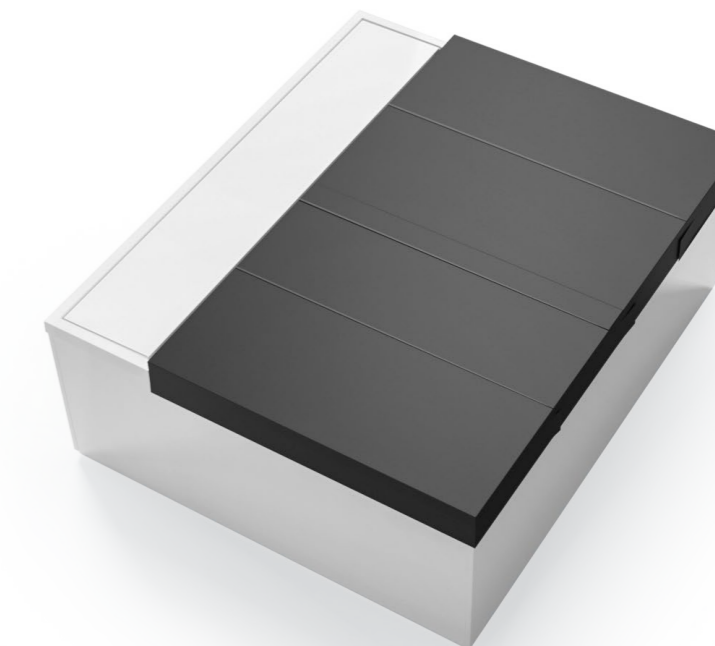

SOUL SPA 120 con contenitore / with storage compartment / avec rangement

# PHANTOM

L. 235 X P. 235 X H. 98 cm

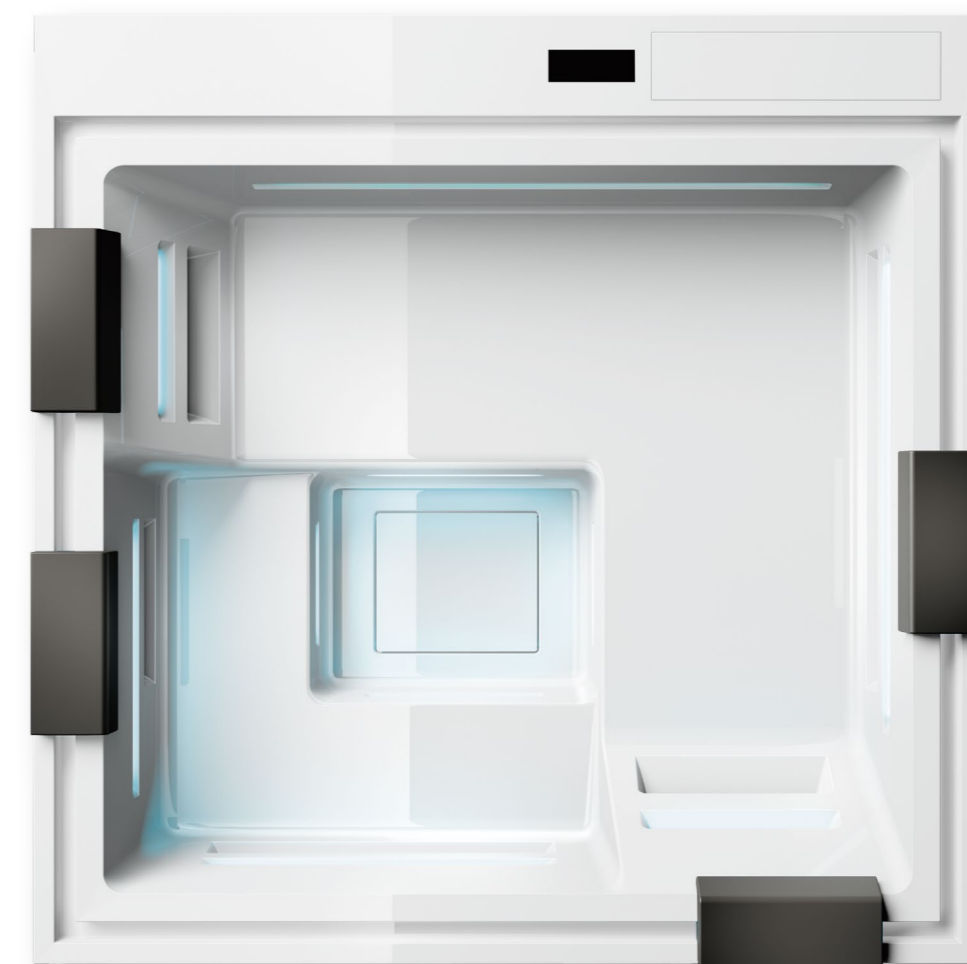

PHANTOM  
L. 235 X P. 235 X H. 98 cm

Colore pannello  
Panel colour  
Couleur du panneau



Bianco satinato  
Satin white  
Blanc satiné

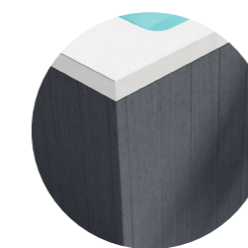

Effetto legno dark  
Dark wood effect  
Effet bois foncé

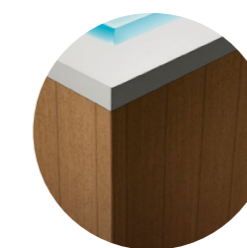

Effetto legno  
Wood effect  
Effet bois

# ZEN ACTIVE

L. 300 X P. 235 X H. 85 cm



**ZEN ACTIVE**  
L. 300 X P. 235 X H. 85 cm

Colore pannello  
Panel colour  
Couleur du panneau



Vetroresina bianco  
White fibreglass  
Fibre de verre blanc

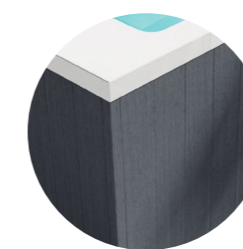

Effetto legno dark  
Dark wood effect  
Effet bois foncé

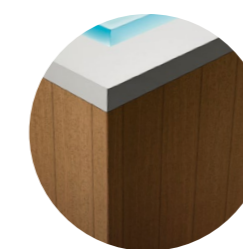

Effetto legno  
Wood effect  
Effet bois

# HEAVEN

L. 210 X P. 210 X H. 86 cm



HEAVEN  
L. 210 X P. 210 X H. 86 cm

Colore pannello  
Panel colour  
Couleur du panneau



Bianco satinato  
Satin white  
Blanc satiné



Nero satinato  
Satin black  
Noir satiné

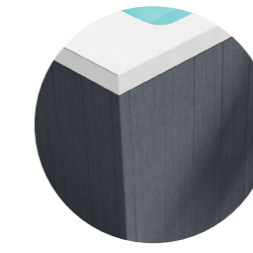

Effetto legno dark  
Dark wood effect  
Effet bois foncé

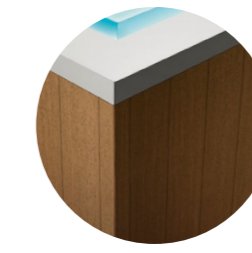

Effetto legno  
Wood effect  
Effet bois



# SHADOW

L. 200 X P. 160 X H. 82 cm



**SHADOW**  
L. 200 X P. 160 X H. 82 cm

Colore pannello  
Panel colour  
Couleur du panneau



Bianco satinato  
Satin white  
Blanc satiné



Nero satinato  
Satin black  
Noir satiné

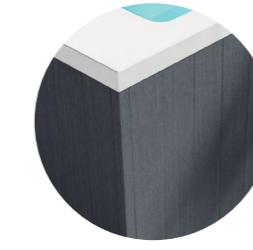

Effetto legno dark  
Dark wood effect  
Effet bois foncé

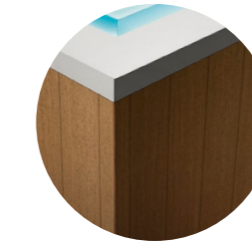

Effetto legno  
Wood effect  
Effet bois

# BREEZE

L. 220 X P. 220 X H. 90 cm  
 L. 210 X P. 210 X H. 90 cm  
 L. 190 X P. 190 X H. 80 cm  
 L. 190 X P. 140 X H. 75 cm

LA NUOVA PROPOSTA CHE AMPLIA IL MONDO DELLE MINIPISCINE POOL. UNO SPAZIO PER IL RELAX, ADATTO SIA ALL'INSTALLAZIONE INDOOR CHE OUTDOOR, CHE PUÒ ARRICCHIRE AMBIENTI PRIVATI E HOTEL. SVILUPPATO DA MARC SADLER, IL SISTEMA POOL PREVEDE BOCCHETTE ALTAMENTE PERFORMANTI, POSIZIONATE A FILO; LA LORO DISPOSIZIONE A GRUPPI FAVORISCE IL COMFORT DI OGNI OSPITE E AL TEMPO STESSO CREA UN PIACEVOLE RITMO VISIVO.

The new proposal added to the world of Pool spas.

A space for relaxation, suitable both indoors and outdoors to enrich private environments and hotels. Developed by Marc Sadler, the Pool system has high-performance nozzles positioned flush with the side; their arrangement in groups promotes each guest's comfort and simultaneously creates a pleasant visual rhythm.

Voici la nouvelle proposition qui ajoute une dimension supplémentaire au monde des mini-piscines Pool. Un espace de détente, adapté aussi bien à l'intérieur qu'à l'extérieur, capable d'enrichir les chambres privées et les hôtels. Développé par Marc Sadler, le système Pool est doté de jets encastrés haute performance dont la disposition en groupes favorise le confort de chaque hôte tout en créant un rythme visuel agréable.



BREEZE 220  
 L. 220 X P. 220 X H. 90 cm



**BREEZE 220**  
L. 220 X P. 220 X H. 90 cm



**BREEZE 210**  
L. 210 X P. 210 X H. 90 cm



**BREEZE 190**  
L. 190 X P. 190 X H. 80 cm



**BREEZE 140**  
L. 190 X P. 140 X H. 75 cm

Colore pannello  
Panel colour  
Couleurs du panneau

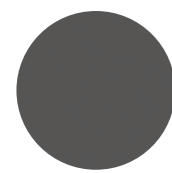

Grigio antracite  
Anthracite grey  
Gris anthracite

# SUPERQUARZ

L. 220 X P. 220 X H. 90 cm



**SUPERQUARZ SP1**  
L. 220 X P. 220 X H. 90 cm

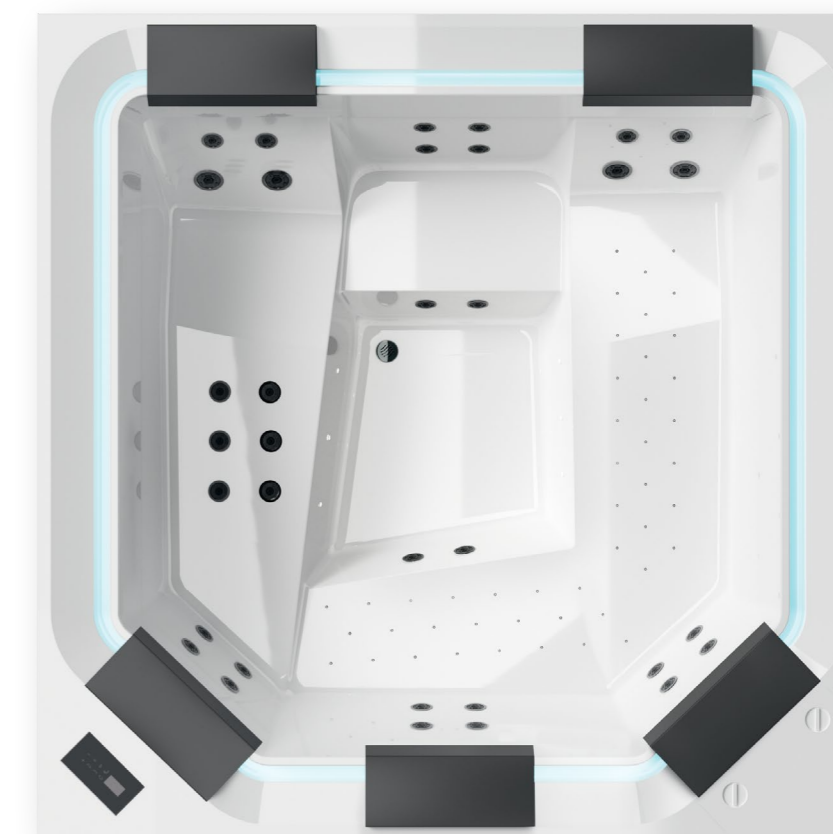

**SUPERQUARZ PR1**  
L. 220 X P. 220 X H. 90 cm

Colore pannello  
Panel colour  
Couleur du panneau

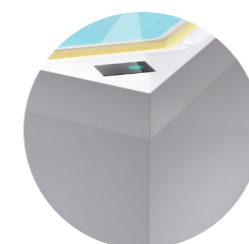

Bianco satinato  
Satin white  
Blanc satiné

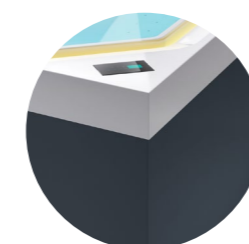

Nero satinato  
Satin black  
Noir satiné

# QUARZ LIGHT

L. 212 X P. 190 X H. 90 cm  
L. 235 X P. 215 X H. 90 cm



QUARZ LIGHT 212  
L. 212 X P. 190 X H. 90 cm



QUARZ LIGHT 235  
L. 235 X P. 215 X H. 90 cm

Colore pannello  
Panel colour  
Couleur du panneau



Nero  
Black  
Noir

# AQUARUN

L. 510 X P. 235 X H. 142 cm

L'ACQUA È RELAX, SOGNO, È ASSAPORARE IL MOMENTO. MA È ANCHE SPORT, ENERGIA, FORZA! CON AQUARUN SI PUÒ GODERE DI UN'ESPERIENZA DI NUOTO COINVOLGENTE, DIROMPENTE, ADATTA ALLO SPORTIVO PROFESSIONISTA COME AL SEMPLICE APPASSIONATO.

DAL PUNTO DI VISTA TECNICO, AQUARUN È UN PRODOTTO INNOVATIVO, CON PRESTAZIONI SUPERIORI E UNO SPAZIO PIÙ AMPIO E CONFORTEVOLE RISPETTO ALLE ALTRE VASCHE PER IL NUOTO CONTROCORRENTE: BEN 235 CENTIMETRI DI LARGHEZZA.

Water is relaxation, dreaming, a delightful moment. But it's also sport, energy, strength! Aquarun lets you enjoy an engaging, breakthrough swimming experience, suitable for both professional athletes or simply for enthusiasts. From a technical point of view, Aquarun is an innovative product due to its superior performance and larger and more comfortable space compared to other pools for counter-current swimming: an impressive 235 cm in width.

L'eau, c'est la détente, c'est le rêve, c'est la joie de vivre. Mais c'est aussi le sport, l'énergie, la force ! Avec Aquarun, vous pouvez profiter d'une expérience de natation passionnante et révolutionnaire, que vous soyez un sportif professionnel ou un simple amateur. D'un point de vue technique, Aquarun est un produit innovant, aux performances supérieures, qui offre un espace plus grand et plus confortable que les autres spas de nage à contre-courant avec une largeur impressionnante de 235 centimètres.



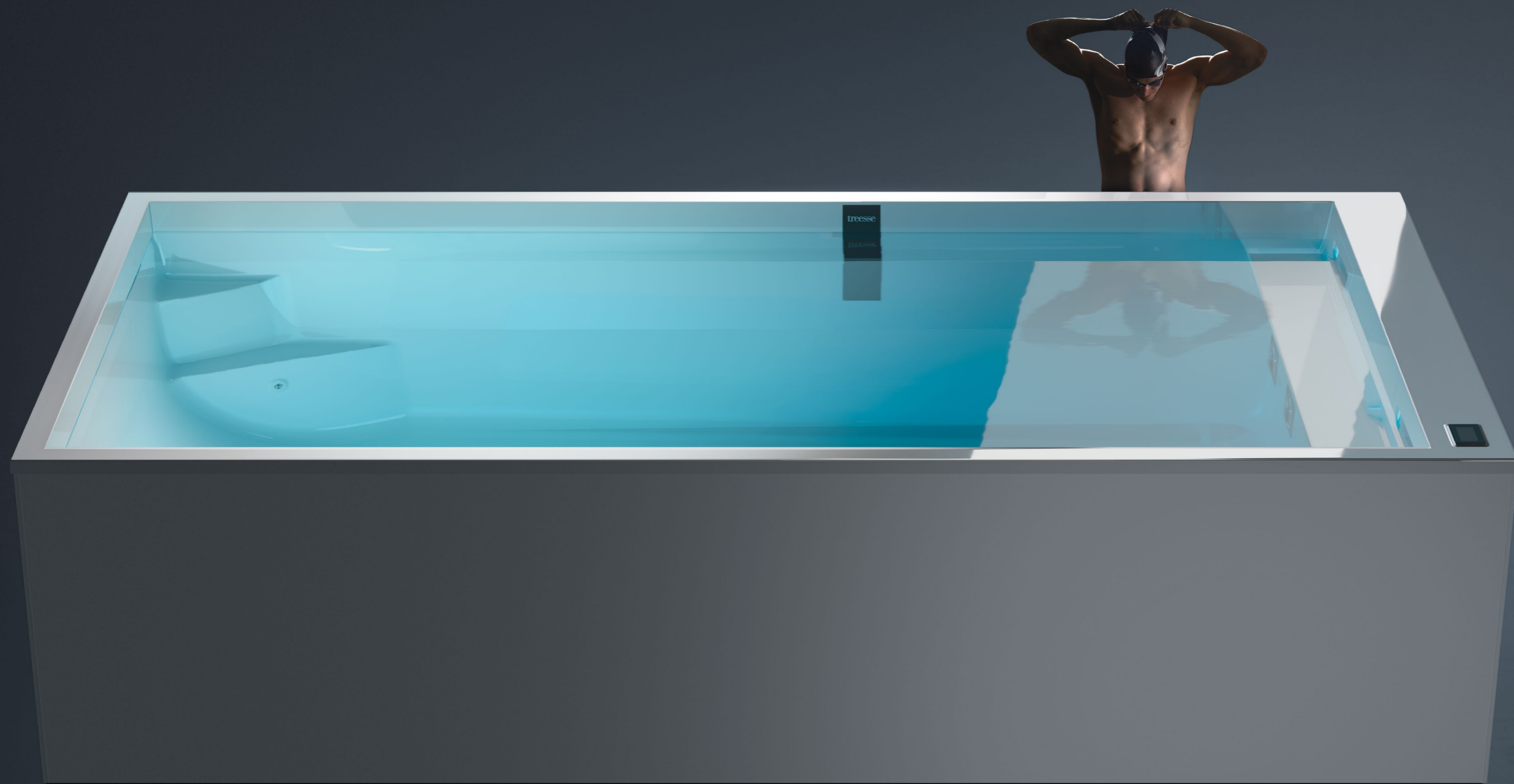

AQUARUN  
L. 510 X P. 235 X H. 142 cm



TURBINE  
Turbines  
Turbines

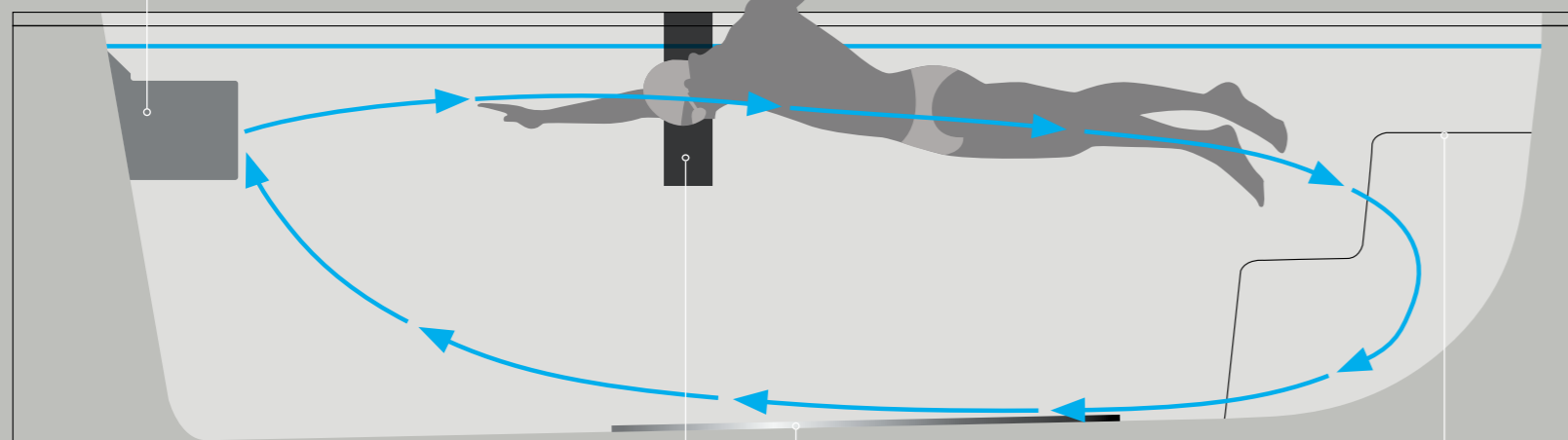

COMANDO  
Control  
Commandes

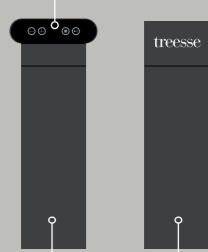

POSIZIONE NUOTATORE  
Swimmer position  
Position du nageur

SUPERFICIE RIFLETTENTE  
Reflective surface  
Surface réfléchissante

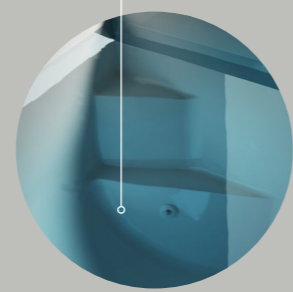

SCALINI INTERNI  
Internal steps  
Marches internes

Colore pannello  
Panel colour  
Couleur du panneau

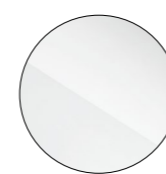

Bianco  
White  
Blanc



**AQUARUN**  
L. 510 X P. 235 X H. 142 cm



**STEP-BOX**

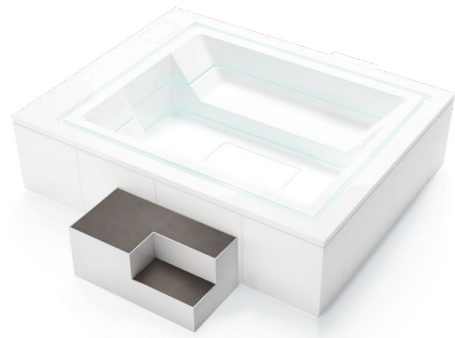

**STEP-BOX** 115 CM

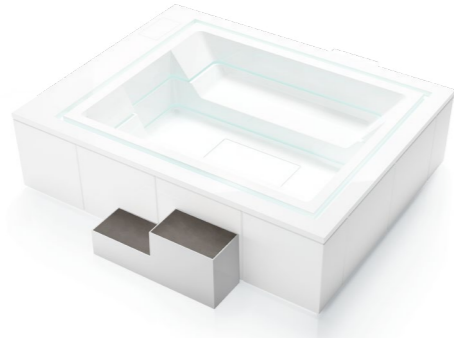

**STEP-BOX** 120 CM

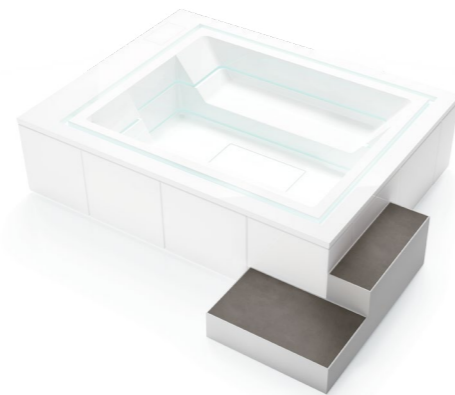

**STEP-BOX** 100 CM

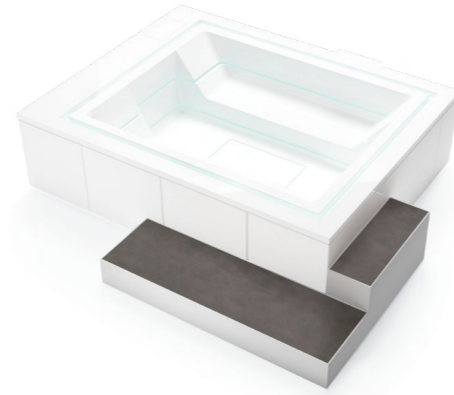

**STEP-BOX** 200 CM

Gradini realizzati in vetroresina e rivestiti con gres effetto pietra naturale, spessore lastra 20 mm  
Steps made of fibreglass and covered with natural stone-effect stoneware, slab thickness 20 mm.  
Marches en fibre de verre et recouvertes de grès effet pierre naturelle, épaisseur de la dalle 20 mm

Disponibile in abbinamento con minipiscine Ghost e Ghost Plus.  
Available to match the Ghost and Ghost Plus spas.  
Disponibile en combinaison avec les mini-piscines Ghost et Ghost Plus

Finitura gres  
Stoneware finish  
Grès finition

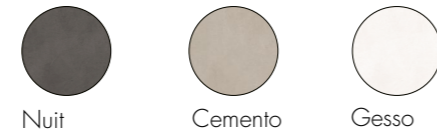

**BIG BANG**

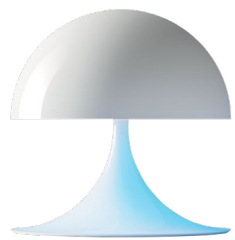

SOUND BY **BOSE**  
COLOUR THERAPY  
BLUETOOTH

**BIG BANG** Ø 55 X H. 55 cm

Disponibile in abbinamento con minipiscine Ghost e Ghost Plus.  
Available to match the Ghost and Ghost Plus spas  
Disponibile en combinaison avec les mini-piscines Ghost et Ghost Plus

**THRONE**

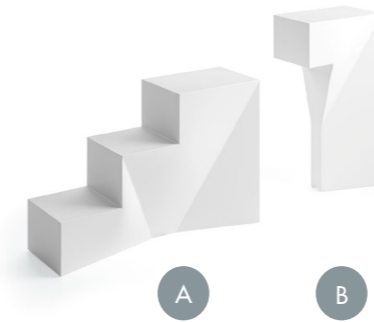

**A** - L. 125 X P. 40 X H. 81 cm  
**A+B** - L. 165 X P. 40 X H. 108 cm

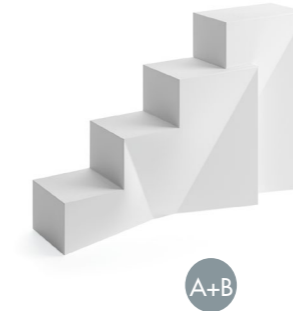

Bianco  
White  
Blanc

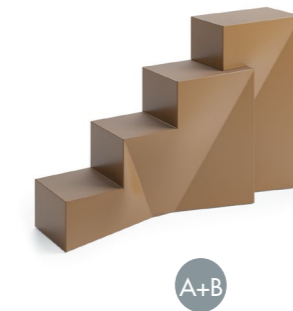

Marrone sabbia  
Sand brown  
Brun sable

Esempi di componibilità  
Examples of modularity  
Exemples de modularité

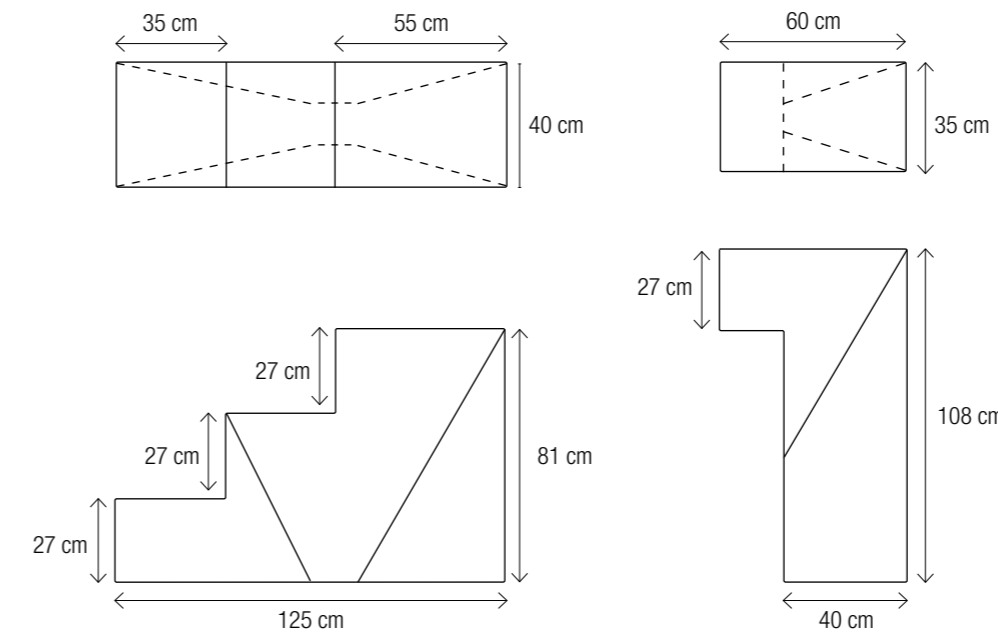
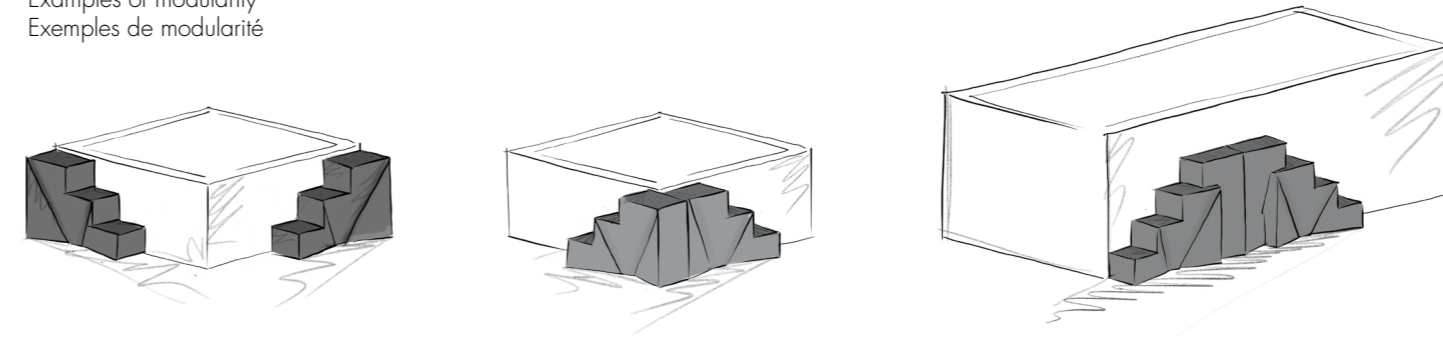

# MIRAGE

L. 350 X P. 210 X H. 230 cm

IL CALORE CHE REGALA BENESSERE. MIRAGE NASCE PER OFFRIRE UNA SOLUZIONE COMPLETA PER PORTARE I BENEFICI DI SAUNA, BAGNO TURCO E DOCCIA ALL'INTERNO DI UN'UNICA CABINA. RAPPRESENTA UN'AREA WELLNESS INTEGRATA, CHE TROVA SPAZIO ALL'INTERNO DI HOTEL, OPPURE PER ABITAZIONI PRIVATE E CHE GARANTISCE I MASSIMI STANDARD TECNICI E DI ELEGANZA. MIRAGE RACCHIUDE IL GUSTO ITALIANO DEL DESIGN E LA TRADIZIONE DELLA SAUNA FINLANDESE, INSIEME, PER RISPONDERE ALLE RICHIESTE DELLA CLIENTELA PIÙ ESIGENTE.

The warmth that brings well-being. Mirage was created to offer a complete solution that includes the benefits of saunas, Turkish baths and showers inside a single cabin.

It is an integrated wellness area that can easily find space inside hotels or private homes, guaranteeing the highest technical standards and elegance.

Mirage encapsulates Italian design taste and Finnish sauna traditions together, meeting the needs of the most demanding customers.

La chaleur, source de bien-être. Mirage a été créé pour offrir une solution complète permettant de réunir les avantages d'un sauna, d'un hammam et d'une douche dans une seule cabine. Il s'agit d'un espace de bien-être intégré qui peut être utilisé dans les hôtels ou les maisons privées et qui garantit les normes techniques et d'élégance les plus élevées. Mirage incarne le goût italien pour le design et la tradition du sauna finlandais, afin de répondre aux demandes des clients les plus exigeants.





MIRAGE  
L. 350 X P. 210 X H. 230 cm

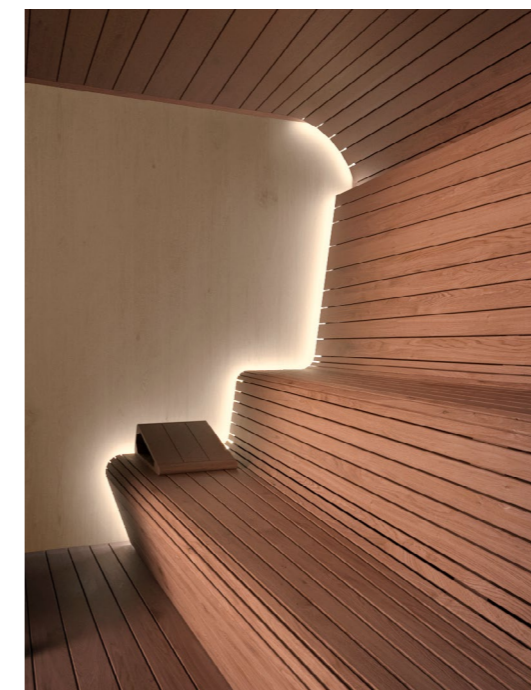
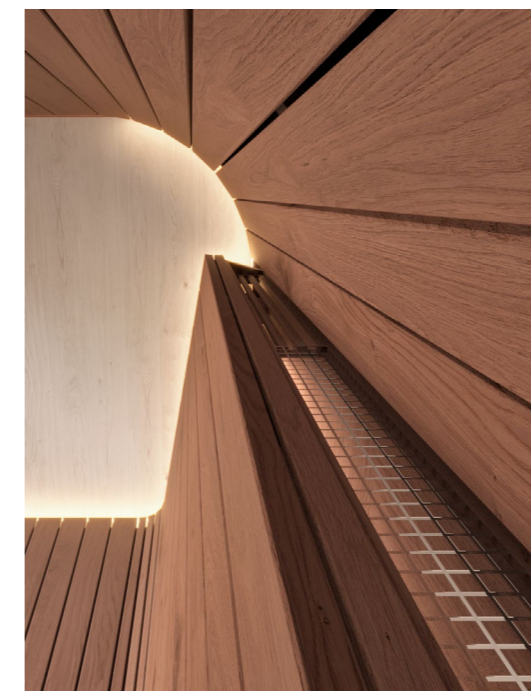

# AURA

L. 160 X P. 120 X H. 216 cm  
L. 180 X P. 120 X H. 216 cm  
L. 180 X P. 150 X H. 216 cm  
L. 200 X P. 150 X H. 216 cm  
L. 200 X P. 200 X H. 216 cm

IL FASCINO DELLA SAUNA FINLANDESE SI INCONTRA CON IL GUSTO ITALIANO DEL DESIGN E CON L'ATTENZIONE DI MARC SADLER A OGNI DETTAGLIO ESTETICO E FUNZIONALE: NASCE COSÌ AURA, UNA SAUNA VERSATILE PER DIMENSIONI E POSSIBILITÀ DI INSTALLAZIONE. LEGNI PREGIATI, ILLUMINAZIONE DELICATA E SOLUZIONI TECNICHE ESALTANO LA PIACEVOLEZZA DELL'ESPERIENZA.

The charm of Finnish saunas meets Italian taste for design and Marc Sadler's attention to every functional and aesthetic detail: thus giving rise to Aura, a versatile sauna for its size and installation possibilities. Fine woods, subtle lighting and technical solutions make the experience even more enjoyable.

L'attrait du sauna finlandais rencontre le goût italien pour le design et le souci du détail – fonctionnel et conceptuel – de Marc Sadler. De cette approche est né Aura, un sauna polyvalent en termes de taille et de possibilités d'installation. Des bois nobles, un éclairage doux et des solutions techniques garantissent une expérience inoubliable.





AURA PUÒ ESSERE REALIZZATA SU MISURA COME LARGHEZZA E PROFONDITÀ, DA UN MINIMO DI 160X120 CM. AD UN MASSIMO DI 200X200 CM. INSTALLAZIONE A NICCHIA, A PARETE, A CENTRO STANZA O AD ANGOLO (SIA DESTRO CHE SINISTRO).

Aura can be customised in width and depth, from a minimum of 160x120 cm to a maximum of 200x200 cm. installation in recesses, against walls, in the middle of the room or a (left or right) corner.

Aura peut être réalisé sur mesure en largeur et en profondeur, d'un minimum de 160x120 cm à un maximum de 200x200 cm. Il peut ainsi être installé dans une niche, contre un mur, au milieu de la pièce ou dans un coin (à gauche ou à droite).

#### AURA

- L. 160 X P. 120 X H. 216 cm
- L. 180 X P. 120 X H. 216 cm
- L. 180 X P. 150 X H. 216 cm
- L. 200 X P. 150 X H. 216 cm
- L. 200 X P. 200 X H. 216 cm

**NEWS**



**ROCK**  
L. 210 X P. 225 X H. 95 cm



**ARTICA**  
L. 195 X P. 90 X H. 80 cm

**GHOST PLUS**

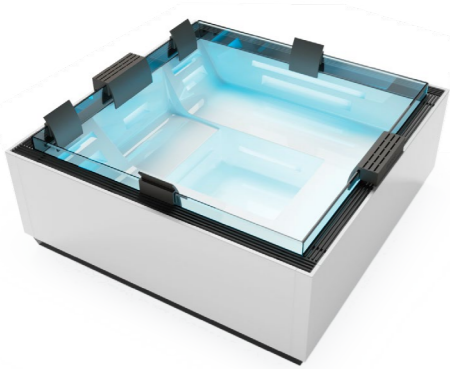

**ICE**  
L. 225 X P. 225 X H. 95 cm

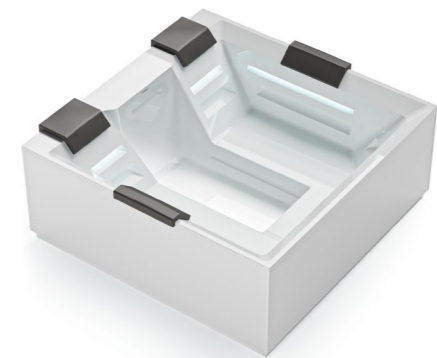

**HEAVEN**  
L. 210 X P. 210 X H. 86 cm



**PHANTOM**  
L. 235 X P. 235 X H. 98 cm



**MUSE GP**  
L. 280 X P. 235 X H. 98 cm



**MAYA GP**  
L. 260 X P. 205 X H. 95 cm



**SHADOW**  
L. 200 X P. 160 X H. 82 cm

**GHOST**



**ZEN**  
L. 280 X P. 235 X H. 85 cm



**ZEN ACTIVE**  
L. 300 X P. 235 X H. 85 cm



**REST**  
L. 240 X P. 195 X H. 85 cm



**WAVE**  
L. 235 X P. 235 X H. 98 cm



**MUSE**  
L. 280 X P. 235 X H. 98 cm



**MAYA**  
L. 260 X P. 205 X H. 95 cm



**FUSION ACTIVE 230**  
L. 230 X P. 200 X H. 67 cm



**FUSION SPA 230**  
L. 230 X P. 180 X H. 67 cm



**FUSION SPA 231**  
L. 230 X P. 150 X H. 67 cm



**FUSION SPA 200**  
Ø 200 x H. 67 cm



**FUSION SPA 220**  
L. 220 X P. 120 X H. 67 cm



**SOUL SPA 150**  
L. 195 X P. 150 X H. 70 cm



**SOUL SPA 120**  
L. 195 X P. 120 X H. 70 cm

**POOL**



**BREEZE 220**  
L. 220 X P. 220 X H. 90 cm



**BREEZE 210**  
L. 210 X P. 210 X H. 90 cm



**BREEZE 190**  
L. 190 X P. 190 X H. 80 cm



**BREEZE 140**  
L. 190 X P. 140 X H. 75 cm

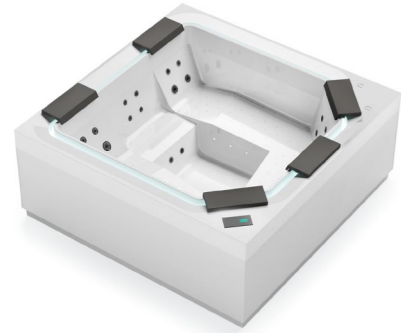

**SUPERQUARZ**  
L. 220 X P. 220 X H. 90 cm



**QUARZ LIGHT 235**  
L. 235 X P. 215 X H. 90 cm



**QUARZ LIGHT 212**  
L. 212 X P. 190 X H. 90 cm

**SWIM SPA**



**AQUARUN**  
L. 510 X P. 235 X H. 142 cm

**ACCESSORI - ACCESSORIES - ACCESSOIRES**

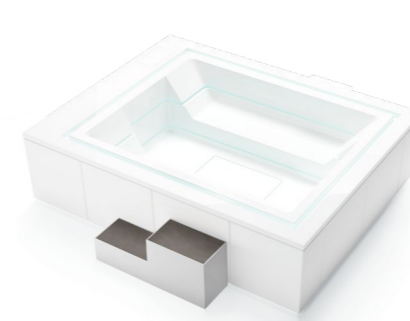

**STEP-BOX 120 cm**

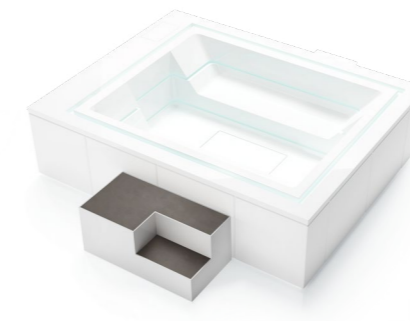

**STEP-BOX 115 cm**

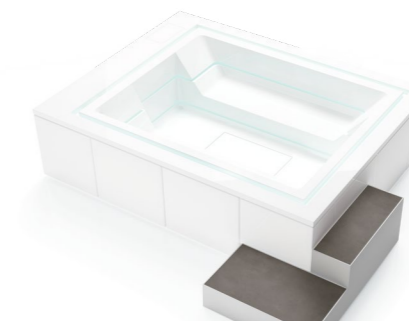

**STEP-BOX 100 cm**

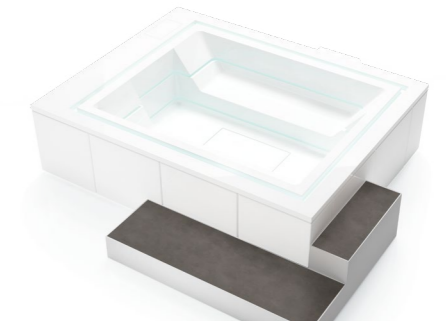

**STEP-BOX 200 cm**

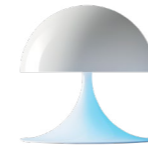

**BIG BANG** Ø 55 X H. 55 cm

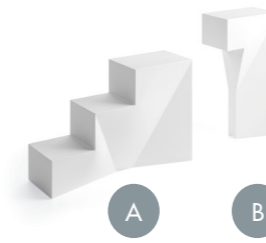

**THRONE A** - L. 125 X P. 40 X H. 81 cm

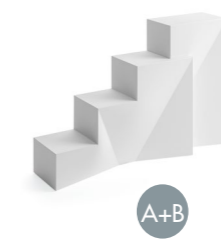

**THRONE A+B** - L. 165 X P. 40 X H. 108 cm

**SAUNA+HAMMAM**



**MIRAGE SAUNA + HAMMAM**  
L. 350 X P. 210 X H. 230 cm

**SAUNA**



**AURA SAUNA**  
L. 160 X P. 120 X H. 216 cm  
L. 180 X P. 120 X H. 216 cm  
L. 180 X P. 150 X H. 216 cm  
L. 200 X P. 150 X H. 216 cm  
L. 200 X P. 200 X H. 216 cm

Concept + Graphic project  
**adhocspaziocreativo.it**

Stylist  
Paola Annunziata

Print  
Cappelli arti grafiche

© Gruppo Tre S s.p.a. 11/2024

treesse  

GRUPPO TRE S s.p.a.

Sede legale - Registered office  
Via Cassia, 698 / 00189 Roma (RM) Italia  
C.F - P.iva 01435630569

Sede operativa - Operational headquarters  
Via degli Imprenditori 8-10 / Zona industriale Settevene / 01036 Nepi (VT) Italia  
Tel (+39) 0761 527242 / Fax (+39) 0761 1765419

[info@gruppotres.it](mailto:info@gruppotres.it) / [www.gruppotreesse.it](http://www.gruppotreesse.it)



I dati e le caratteristiche indicate non impegnano il Gruppo Tre S spa, che si riserva il diritto di apportare delle modifiche ritenute opportune senza obbligo di preavviso o di sostituzione. I colori e i materiali riprodotti nelle immagini stampate hanno un valore indicativo.

The information and descriptions provided are not binding for Gruppo Tre S spa, which reserves the right to make any changes it considers necessary without any obligations of pre-notification or replacement. The colors and materials reproduced in the printed images are indicative only.

Les données et les caractéristiques indiquées n'engagent pas le Gruppo Tre S spa, qui se réserve le droit d'apporter toute modification jugée opportune sans préavis ni remplacement. Les couleurs et les matériaux reproduits dans les images imprimées sont purement indicatifs.



